

Droite poussant

INT

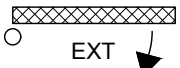

Gauche poussant

INT

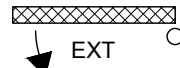

Droite poussant

EXT

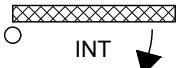

Gauche poussant

EXT

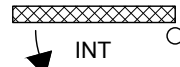

Référence des portes à 2 vantaux

M302L - M302LU - M302LH - M302LHU
M302SA - M602L - M602LU - M602LS - M602LH - M602LHU - M602LHS

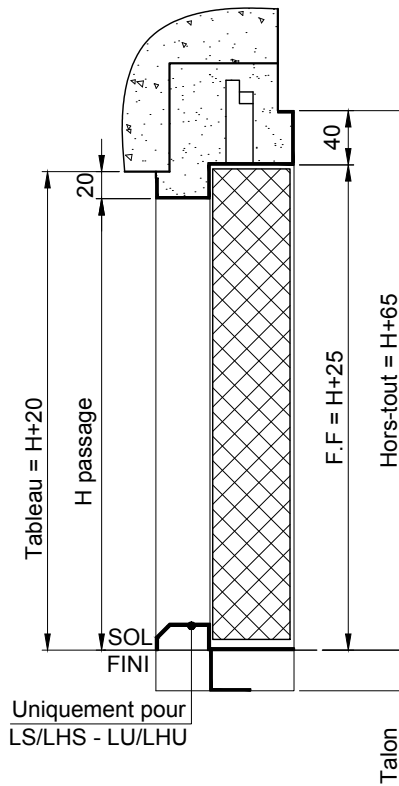
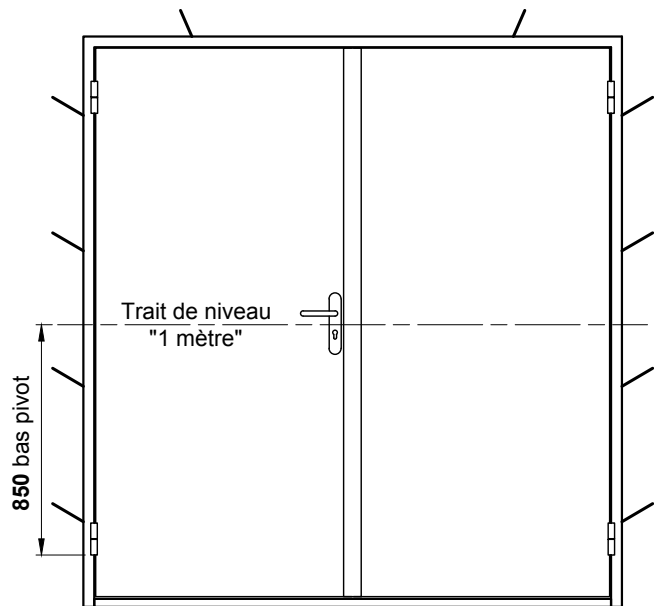

Bâti

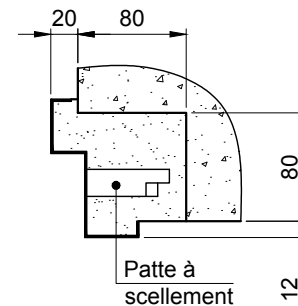

Bâti ISO



Tableau = L+40

L passage

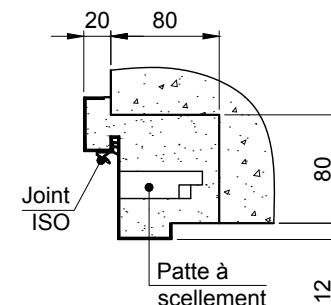
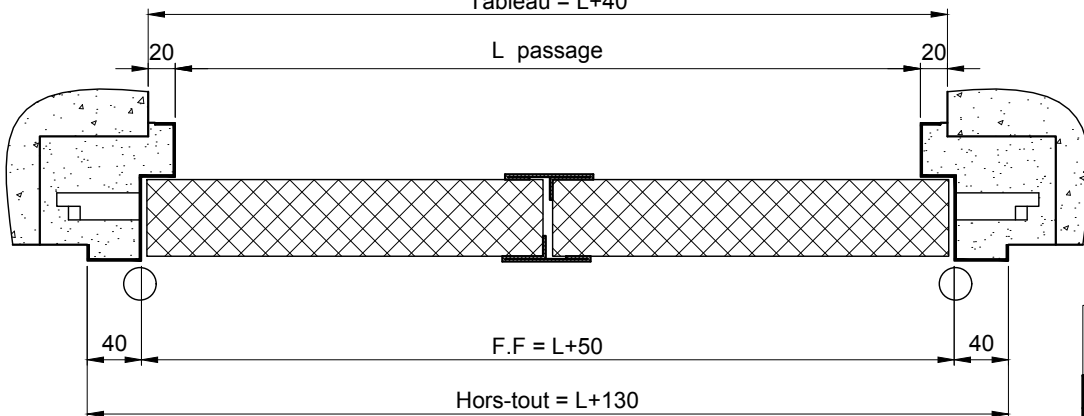

ATTENTION: Le calfeutrement du bâti doit être réalisé au mortier de ciment.

Client:

Chantier:

Date:

Ce plan est la propriété de la société MALERBA. Il ne peut être reproduit ou divulgué sans notre autorisation.

N° plan: X23-7-0024 / 0 Mise en oeuvre pour: PMT BATTANTE EI30 - EI60 - EI120 2V

Titre: BATI A SCELLER AVEC FEUILLURE

Rue Paul Malerba 69470 Cours-la-Ville Tél: 04.74.89.85.85

